

Name: SoundArt BTA-6

# SOUND ART<sup>TM</sup> SPEAKER SERIES

Installation Guide & Operating Instructions

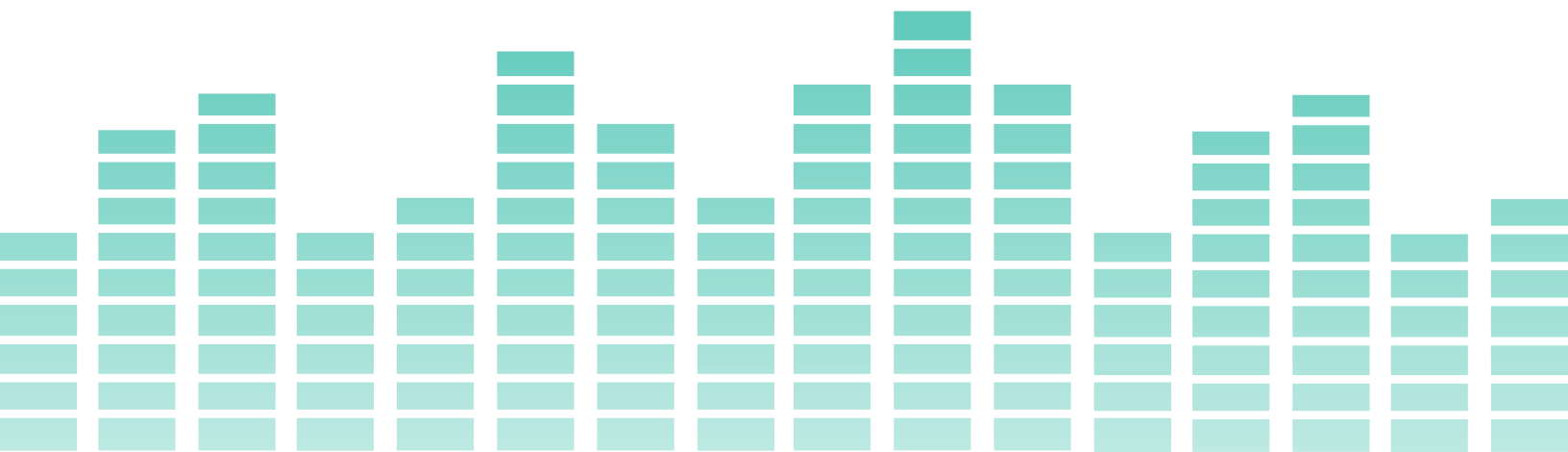

ART NEVER SOUNDED SO GOOD<sup>TM</sup>

## **INTRODUCTION**

Thank you for choosing *Bluetooth®* Sound Art™ by ONSIA®. These unique flat-panel speakers, concealed in Sound Art™ frames, have reliable, proven components and a proprietary design that will provide a truly enjoyable listening experience. *Bluetooth®* Sound Art™ speakers have been designed to be compatible with *Bluetooth®* wireless technology-enabled smartphones, laptops, tablets and PCs. We've developed this installation guide to give you step-by-step pointers for a successful do-it-yourself install. Please read this installation guide & operating instructions document completely before you start. If you have doubts about completing this installation, you should contact a qualified contractor, or a professional audio/video installer. The facility where you purchased your *Bluetooth®* Sound Art™ speaker can refer you to a qualified installer in your area.

## **LIMITATION OF LIABILITY**

*DEDICATED SOUND AND AUDIO AND ITS AFFILIATES DO NOT MAKE ANY GUARANTEES, EXPRESSED OR IMPLIED, INCLUDING MERCHANT ABILITY AND FITNESS FOR PURPOSE, WITH RESPECT TO ANY OF THESE SUGGESTIONS OR INSTRUCTIONS. DEDICATED SOUND AND AUDIO SHALL NOT BE LIABLE FOR ANY SPECIAL, INDIRECT, INCIDENTAL OR CONSEQUENTIAL DAMAGES, INCLUDING BUT NOT LIMITED TO LOSS OF PROFITS, LOSS OF USE, COST OF REPLACEMENT, BREACH OF CONTRACT, INJURY, OR ANY OTHER CAUSE WHATSOEVER EVEN IF DEDICATED SOUND AND AUDIO HAS BEEN ADVISED OF THE POSSIBILITY OF SUCH DAMAGES.*

## **IMPORTANT SAFETY INSTRUCTIONS**

### **General Instructions**



- Read these instructions before using or installing this product.
- Keep these instructions for future reference.
- Heed all warnings in this guide.
- Follow all instructions.
- Install and operate in accordance to this document's instructions only.

### **Fire and Electric Shock Hazard**



- DO NOT open, dismantle, disassemble or modify speaker.
- DO NOT block any ventilation openings.
- DO NOT expose to excessive cold, heat, humidity or direct sunlight.
- DO NOT push objects into holes or any openings.
- ONLY use wall charger supplied.
- Turn off power in areas you'll be drilling when installing unit to avoid electric shock.

### **Safety Tips When Working on a Ladder**



- Place ladder in a stable position close to where you will be working. Don't reach.
- Face ladder and always have two hands on the ladder when ascending or descending.
- Don't carry items up the ladder that could cause you to lose your balance and fall. Have someone hand you items once in a stable position.

## **FCC STATEMENT**

This equipment has been tested and found to comply with the limits for a Class-B digital device, pursuant to Part 15 of the FCC Rules. The limits are designed to provide reasonable protection against harmful interference in a residential installation. This equipment generates, uses and can radiate radio frequency energy and, if not installed and used in accordance with the instructions, may cause harmful interference to radio communication. However, there is no guarantee that harmful interference will not occur in a particular installation. If this equipment does cause harmful interference to radio or television reception, which can be determined by turning the equipment off and on, the user is encouraged to try to correct the interference by one or more of the following measures:

- Reorient or relocate the receiving antenna.
- Increase the separation between the equipment and receiver.
- Connect the equipment into an outlet on a circuit different from that to which the receiver is connected.
- Consult the dealer or an experienced radio/TV technician for help.

Caution: Any changes or modifications to this device not explicitly approved by the manufacturer could void your authority to operate this equipment.

This device complies with Part 15 of the FCC Rules. Operation is subject to the following two conditions: (1) This device may not cause harmful interference, and (2) This device must accept any interference received, including interference that may cause undesired operation.

## **INSTALLATION GUIDE**

### **Recommended Tool List (Wall Mount Units)**

Phillips screw driver, Hammer, Pencil, Measuring tape, Level, Drill and Ladder.

### **Package Contents**

- 1 *Bluetooth*® Sound Art speaker.
- 1 Wall Charger.
- 1 Wall Mount Kit: Z bar (2 pieces) and Wall screws.
- 1 Installation guide & operating instructions document.

### **General Speaker Placement**

Because of the unique technology used in the design of your *Bluetooth*® Sound Art™ speaker, there is more flexibility in placing it relative to the primary listening area. In other words, the location of the speaker can be based on interior design requirements as well as acoustical considerations. However, do not place your Sound Art™ in corners, as this tends to create reverberation and sonic reflections.

### **Mounting Height**

When determining the mounting height, simply follow the same principles that you normally do when hanging traditional artwork. The height of the speaker is conditional to the area. If it is to be located in a living room, dining room, or bedroom, where people are seated, then it should be hung at eye level. The eye will be drawn to the focus of interest in the art or picture, and sound will be at ear level. In hallways and entrance ways, consider the fact that people will be standing, and eye level (and ear level) will change accordingly.

### **Installation on Wall**

- Determine the position on the wall where you would like the top of the speaker to be positioned and lightly mark the wall with a pencil at the center point of the top edge of the frame.
- Measure 1 1/8" below your pencil mark and draw a horizontal line using a level.
- Centrally and along this line mark the hole placements 2" apart.
- Attach the Z bar pieces to the wall and your speaker using the hardware provided as shown in the diagram below. Attach one piece of Z bar to the wall with the wall anchors and wall anchor screws provided. Attach the remaining Z bar piece to your speaker with the machine screws provided. Your speaker has metal screw inserts that allow you to hang it in a horizontal or vertical configuration. Choose the appropriate configuration according to the art on your speaker.
- To hang the speaker, gently slide the unit down the wall until the two sections of Z bar interlock. It is important to ensure that the top piece is fully seated with the bottom piece (you should feel the pieces sliding together).
- Gently pull down on the speaker to make sure that it is secure.

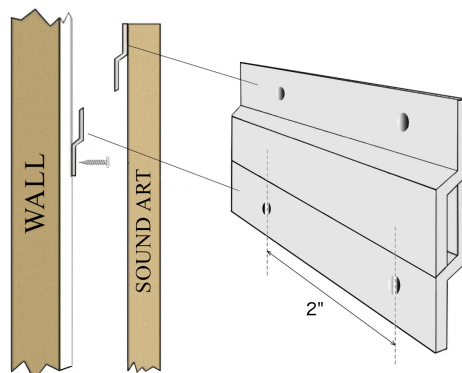

## **OPERATION**

### **1) Charge it. Charger model SMC-3, SMC-7**

**It's recommended to charge your Bluetooth® Sound Art™ speaker unit completely after unpacking.**

Connect the wall charger unit to an AC outlet and to the DC jack located on the bottom part of the Sound Art speaker frame.

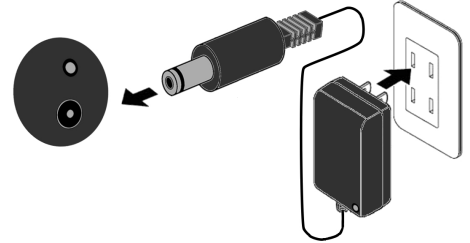

A **red** LED indicator on the wall charger indicates the Sound Art speaker is charging.

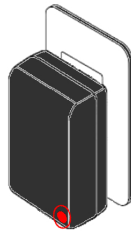

A **green** LED indicator on the wall charger indicates the speaker is fully charged and can be unplugged.

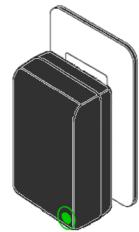

### **2) Power it.**

Slide the switch on the back of your Sound Art speaker to the "ON" position. When the Bluetooth Sound Art speaker is powered on, you will hear a series of tones indicating the unit is ready to be paired or play music.



A **blue** LED indicator located next to the DC jack will turn ON and will remain ON to indicate the unit is powered.

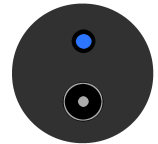

Once your speaker is mounted on the wall you may leave the unit ON. Your speaker will automatically enter a power saving mode when not in use.

### **3) Pair it. Play it. Love it!**

To pair your Bluetooth® Sound Art™, enable Bluetooth® on your music source device and scan for Bluetooth® devices (read your device's manual or user's guide to add or setup a Bluetooth® device). Pair your device with the Bluetooth® device named "SoundArt BTA-6". Password is 1234.

Your Bluetooth® Sound Art™ will give you many hours of enjoyable wireless play time on a single charge. When it's time to recharge, it will let you know by flashing its LED power indicator continuously.

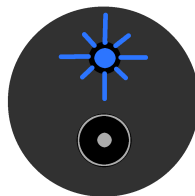

Your Bluetooth® Sound Art™ speaker can be played and recharged at the same time.

## **TROUBLESHOOTING GUIDE**

If your speaker appears to have a problem, the following notes may help. If the problem still persists after having attempted to resolve it, consult your dealer for assistance or contact customer support at ONSIA® through [www.onsia.com](http://www.onsia.com) or by calling customer service at: 1-800 279-7686

<b>Symptom</b>	<b>Possible Cause</b>
No sound at all	<ul style="list-style-type: none"> <li>-Check speaker is powered ON.</li> <li>-Check volume and mute settings on music source device.</li> <li>-Check device is paired.</li> <li>-Recharge speaker.</li> <li>-Reset speaker. Press power key three seconds to power "OFF". Press power Key one second to turn "ON".</li> </ul>
Unable to pair device	<ul style="list-style-type: none"> <li>-Check speaker is powered ON.</li> <li>-Make sure speaker is not paired to another device.</li> <li>-Place music source device in direct line of sight and within 20 feet. Objects, walls, and moving persons may reduce wireless operating range.</li> <li>-Reset speaker. Press power key three seconds to power "OFF". Press power Key one second to turn "ON".</li> </ul>
Music breaks, device disconnects	<ul style="list-style-type: none"> <li>-Place music source device in direct line of sight and within 20 feet. Objects, walls, and moving persons may reduce wireless operating range.</li> <li>-If using a streaming music service, try playing music stored in music source device instead.</li> </ul>
Distortion at high volume levels	<ul style="list-style-type: none"> <li>-Check the recording quality of the music material.</li> <li>-Recharge speaker if LED power indicator is flashing.</li> </ul>

## **SPECIFICATIONS**

### Battery Life:

BP-3: 13 hours (50% volume level). Will vary depending upon audio content.

BP-4: 15 hours (50% volume level). Will vary depending upon audio content.

Charging Time: SMC-3 or SMC-7 BP-3: 4.1 hours BP-4: 4.7 hours

Standby Time: BP-3 45 days; BP-4 50 days

Audio Output Power: 10 watts RMS, THD (@1kHz): 1% @ 7.5W RMS, 10% @ 10W RMS

Frequency Range: 65Hz to 6kHz

Bluetooth Version: 4.0

Loudspeaker Design: Distributed Mode

Sound Dispersion Angle: 170°

Maximum Wireless Range: 33 feet under ideal conditions (direct line of sight)

Battery: Li-Ion

Wall Charger:

SMC-3: Input - 100V to 240V AC 50/60Hz 1.0A max

Output: 12.6 V DC x 1.90A

SMC-7: Input - 100V to 240V AC 50/60Hz 1.0A max

Output: 12.6 V DC x 2.00A

## **PRODUCT CARE**

Do not use any solvents or liquids to clean your *Bluetooth®* Sound Art™ speaker. Simply dust unit with a dry piece of cloth.

## **WARRANTY INFORMATION**

Onsia® warrants its *Bluetooth®* Sound Art™ speaker products to be free from defects in material and workmanship for one year from the date of purchase. This product contains no user serviceable parts. *DO NOT attempt to open, dismantle, disassemble or modify the unit; doing so will void its warranty.* Except where prohibited by applicable law, this warranty is nontransferable and is limited to the original purchaser. This warranty gives you specific legal rights and you may also have other rights that vary under local laws.

In the event of a defect, Onsia® will, at its option, repair or replace the product with no charge to the purchaser for parts or labor. The repaired or replaced product will be warranted for 90 days from the date of return shipment or for the balance of the original warranty, whichever is longer.

To obtain warranty service, the purchaser must call ONSIA® at 1 (800) 279-7686. To obtain a return authorization, the purchaser must provide a copy of the original sales receipt. The purchaser must return the product postpaid with the purchaser's return address and the return authorization information clearly printed on the outside of the package to the Authorized ONSIA® Service Center provided. Dedicated Sound and Audio will not be responsible for any losses or damage to the product incurred while the product is in transit or is being shipped for repair. Insurance is highly recommended.

**THIS PAGE INTENTIONALLY LEFT BLANK**



[www.onsia.com](http://www.onsia.com)

©2016 Dedicated Sound and Audio, Inc. All rights reserved. The ONSIA® logo, ONSIA®, *Art Never Sounded So Good*™, *Sound Art*™, and *Your Wall. Your Sound. Your Art.*™ are trademarks owned by Dedicated Sound and Audio, Inc. The *Bluetooth*® word mark and logos are registered trademarks owned by Bluetooth SIG, Inc. and any use of such marks by Dedicated Sound and Audio, Inc. is under license.